

ESD

>1A

15ns

150ns

- 1.
- 2.
- 3.
4. ESD

IEC61000-4-2 Electromagnetic compatibility (EMC) - Part 4-2: Testing and measurement techniques - Electrostatic discharge immunity test  
GB/T17626.2

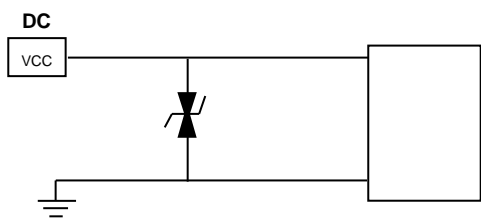
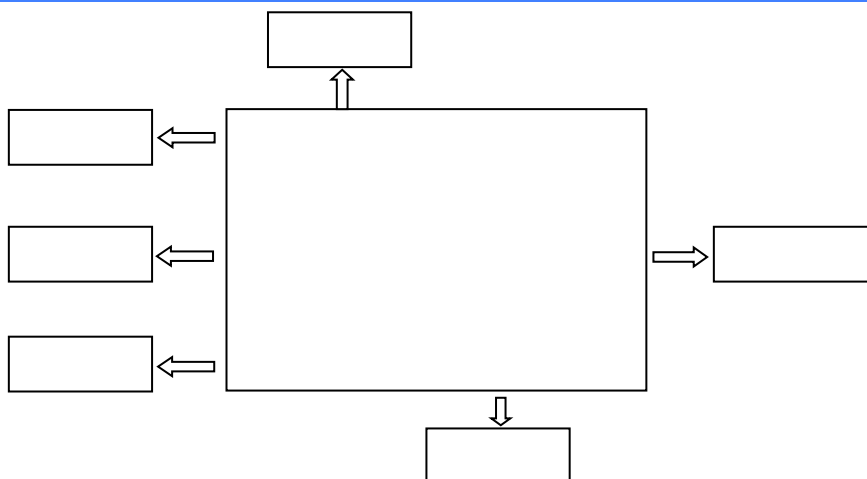

6VDC                      ESD8V0D3B  
12VDC                     ESD15VD3B

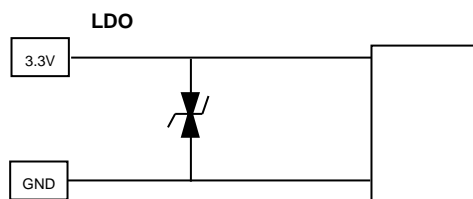

ESD3V3D3B

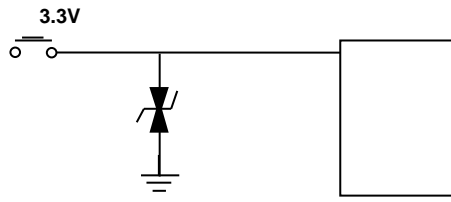

ESD3V3D3B

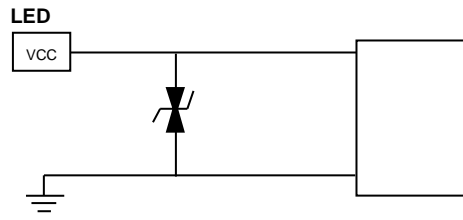

ESD3V3D3B

USB2.0

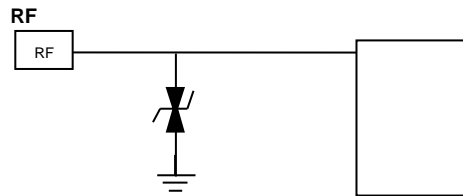
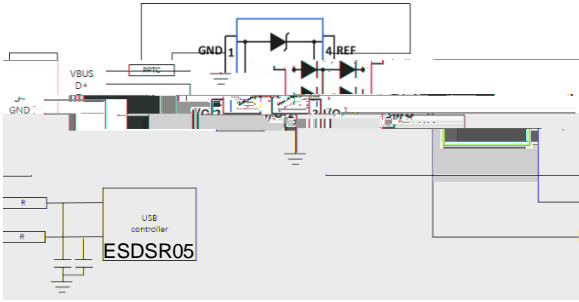

ESDULC5V0D8B